

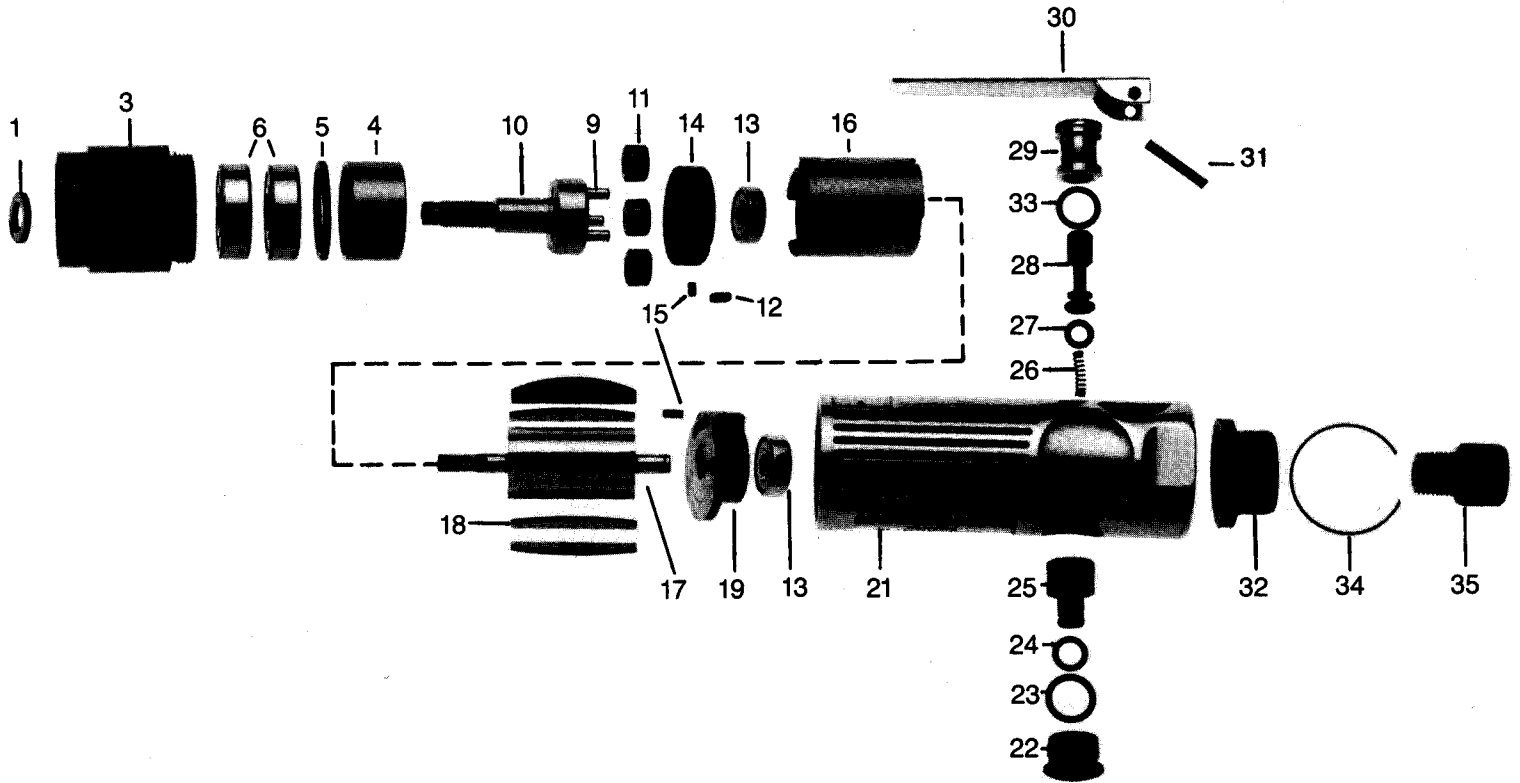

STRAIGHT PNEUMATIC MOTOR
PARTS LIST



253-56 POWER UNIT
S/N 101 & HIGHER

*Use 154-47 Spacer on model PN-1000 Nibbler

*Use 154-50 Spacer on models P-1060 & P-1080 Shears

Index No.	Part Number	Description	Req'd Tool	Index No.	Part Number	Description	Req'd Tool
1	154-*	Spacer	1	21	820020	Motor Housing	1
3	820002	Clamp Nut	1	22	820021	Retaining Screw	1
4	820003	Internal Gear	1	23	820022	"O" Ring	1
5	820004	Large Spacer	1	24	820023	"O" Ring	1
6	820005	Ball Bearing	2	25	820024	Air Regulator	1
9	820008	Planet Pin	3	26	820025	Spring	1
10	820009	Planet Spindle	1	27	820026	"O" Ring	1
11	820010	Planet Gear & Bushing	3	28	820027	Throttle Valve	1
12	820011	Key	1	29	820028	Valve	1
13	820012	Ball Bearing	2	30	820029	Throttle Leaver	1
14	820013	Front End Plate	1	31	820030	Lever Pin	1
15	820014	Pin	2	32	820031	Exhaust Deflector	1
16	820015	Cylinder	1	33	820032	"O" Ring	1
17	820016	Rotor	1	34	820033	Retaining Clip	1
18	820017	Rotor Blade	4	35	820034	Inlet Bushing	1
19	820018	Rear Plate	1				



INSTRUCTIONS FOR THE CARE OF THE KETT 40-20 SHEAR HEAD

CAUTION
Disconnect Power Unit
Before Servicing Tool



PARTS LIST

40-21	Center Blade
40-23	Shear Housing
40-24	Eccentric Bearing Assembly
40-27	Spacer Bushing
92-28	Cap Screw (3)
92-31	Knurled Insert (3)
60-22L	Side Knife, Left
60-22R	Side Knife, Right
60-25	Thin Washer, Large
60-27	Spacer Bushing
60-29	(150-4) Allen Wrench

DISASSEMBLY: To remove the shear head from the motor loosen three cap screws (92-28). Remove shear head from motor by pulling head firmly forward. Slight tapping with a mallet may be required if head does not slide off easily.

To remove cutter blades from shear head remove three cap screws (92-28) from shear housing (40-23). Be careful not to lose rear spacer bushing (60-27) when removing the middle cap screw. Remove center blade (40-21) from shear housing by tapping blade gently rearward. Be careful not to lose spacer bushing (40-27) from hole in center blade. Side knives (60-22L and 60-22R) will now drop out of the shear housing.

To remove eccentric bearing assembly (40-24) from shaft use an appropriate wrench to loosen eccentric nut by turning counter clockwise.

ASSEMBLY: To install eccentric bearing assembly (40-24) onto shaft, make sure the large thin washer (60-25) is first inserted over the shaft. Screw eccentric bearing assembly on to shaft and tighten with appropriate wrench. Lubricate bearing with a good grade of bearing grease.

To install cutter blades into shear housing (40-23) place the side knives (60-22L and 60-22R) into position

in the shear housing (40-23). Insert center cap screw (92-28) through the side knives (60-22L and 60-22R) with rear spacer bushing (60-27) between them and start cap screw into thread just enough to hold blades in place. **DO NOT TIGHTEN.** Insert spacer bushing (40-27) into hole in center blade (40-21) and lubricate with Molybdenum Disulfide grease (264-2) or equivalent. Install center blade into shear housing by tapping blade gently forward using a drift to line up hole in center blade with forward holes in housing. Insert and tighten forward cap screw (92-28) making sure spacer bushing (40-27) in center blade stays in position. Apply Molybdenum Disulfide grease (264-2) or equivalent to clevis or yoke in center blade where it rides on the eccentric bearing assembly. Insert rear cap screw (92-28) into shear housing, but do not completely tighten.

To install shear head assembly onto drive motor make sure all cap screws (92-28) are loosened about three or four complete turns. Spread shear housing (40-23) slightly using a spreader (drift) near the rear cap screw (92-28). Place shear head onto unit, tap left side knife rearward as far as it will go, and tighten cap screws to 40-45 inch pounds. It may be necessary to gently tap the shear head into place if it does not readily slip onto the nose of the power unit.

WARNING: THE KETT TOOL CO. CANNOT ASSUME RESPONSIBILITY FOR DAMAGE TO OR MALFUNCTION OF A KETT SHEAR HEAD USED IN COMBINATION WITH ANY DRILL OTHER THAN THOSE REGULARLY SUPPLIED BY US.